

## Dimensions HTP/G in mm

Dimension	HTP/G 500		HTP/G 1000		HTP/G 2000		HTP/G 3000		HTP/G 5000		HTG 10000	HTG 20000
	A	B	A	B	A	B	A	B	A	B	B	B
A	77,0	92,0	82,5	97,5	98,5	113,5	114,0	129,0	132,5	147,5	276,0	270,0
B	-	-	-	-	-	-	-	-	-	-	52	70
D	16	16	17	17	22	22	26	26	33	33	30	35
D <sub>1</sub>	25	25	30	30	40	40	48	48	60	60	80	110
D <sub>2</sub>	30	30	35	35	47	47	58	58	70	70	114	155
F (HTG)	91,5	91,5	91,5	91,5	90,5	90,5	107,5	107,5	149,5	149,5	113,0	113,0
F <sub>1</sub>	46,0	46,0	46,0	46,0	46,0	46,0	46,0	46,0	45,5	45,5	-	-
H <sub>1</sub>	30,5	45,5	30,5	45,5	30,5	45,5	30,0	45,0	30,0	45,0	45,0	45,0
I (HTP)	71,5	71,5	71,5	71,5	95,5	95,5	131,0	131,0	142,5	142,5	-	-
I (HTG)	76,5	76,5	76,5	76,5	98,0	98,0	132,5	132,5	148,5	148,5	170,0	170,0
L	260	260	260	260	310	310	390	390	450	450	430	870
L <sub>1</sub>	130	130	130	130	150	150	180	180	209	209	200	200
L <sub>2</sub>	-	-	-	-	-	-	-	-	-	-	-	115
O	60	60	60	60	80	80	112	112	125	125	150	150
P (HTG)	110	110	110	110	110	110	110	110	110	110	163	163
P <sub>1</sub>	168	168	168	168	168	168	168	168	168	168	-	-
P <sub>2</sub>	146,0	146,0	150,0	150,0	155,0	155,0	160,0	160,0	167,5	167,5	-	-
T	146,0	187,0	150,0	187,0	155,0	189,5	160,0	191,5	167,5	191,5	270,0	270,0

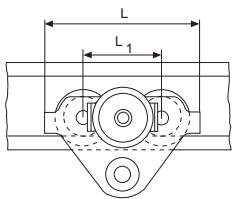

**Model HTP/G**  
500 - 5.000 kg

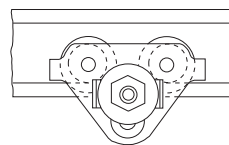
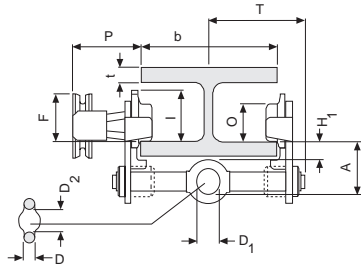

**Model HTP/G  
with locking device**  
500 - 5.000 kg

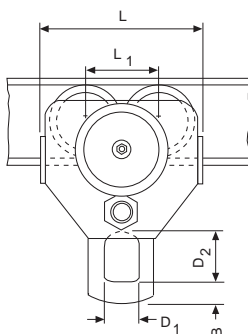
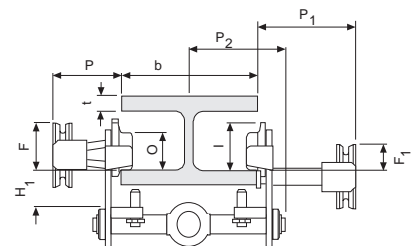

**Model HTG**  
10.000 kg

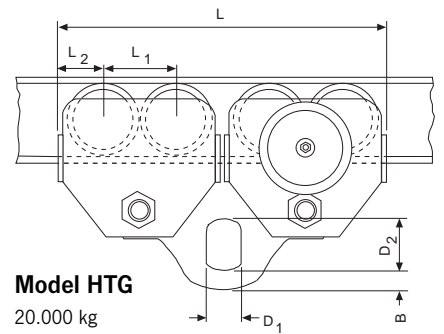
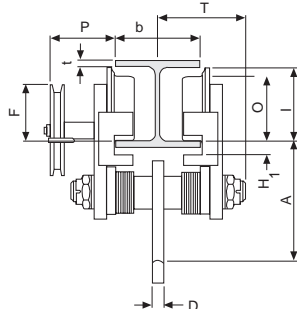

**Model HTG**  
20.000 kg